



MBR1040CT - MBR10200CT

Features

- Low power loss, high efficiency. High surge capacity.
- For use in low voltage, high frequency inverters, free wheeling, and polarity protection applications.
- Metal silicon junction, majority carrier conduction.
- High current capacity, low forward voltage drop.
- Guard ring for over voltage protection.

TO-220

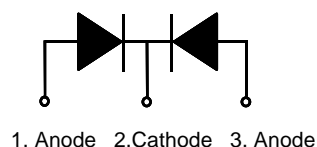
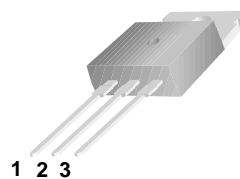

Absolute Maximum Ratings*

T = 25°C unless otherwise noted

PARAMETER	SYMBOL	1040CT	1045CT	1050CT	1060CT	1080CT	1090CT	10100CT	10150CT	10200CT	UNITS	
Maximum Recurrent Peak Reverse Voltage	V_{RRM}	40	45	50	60	80	90	100	150	200	V	
Maximum RMS Voltage	V_{RMS}	28	31.5	35	42	56	63	70	105	140	V	
Maximum DC Blocking Voltage	V_{DC}	40	45	50	60	80	90	100	150	200	V	
Maximum Average Forward Current	$I_{F(AV)}$	10									A	
Peak Forward Surge Current : 8.3 ms single half sine-wave superimposed on rated load (JEDEC method)	I_{FSM}	150									A	
Maximum Forward Voltage at 5A per leg	V_F	0.7		0.75		0.85			0.95		V	
Maximum DC Reverse Current at Rated DC Blocking Voltage $T_J=25^\circ\text{C}$ $T_J=125^\circ\text{C}$	I_R	0.1					20					mA
Typical Thermal Resistance	$R_{\theta JC}$	1.4										$^\circ\text{C} / \text{W}$
Operating Junction and Storage Temperature Range	T_J, T_{STG}	-55 to +150				-65 to +175					$^\circ\text{C}$	

Typical Characteristics

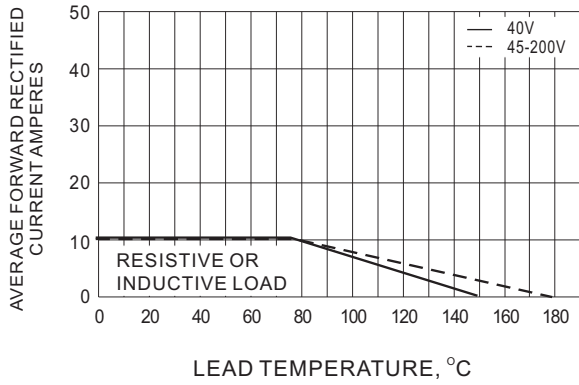

Fig.1- FORWARD CURRENT DERATING CURVE

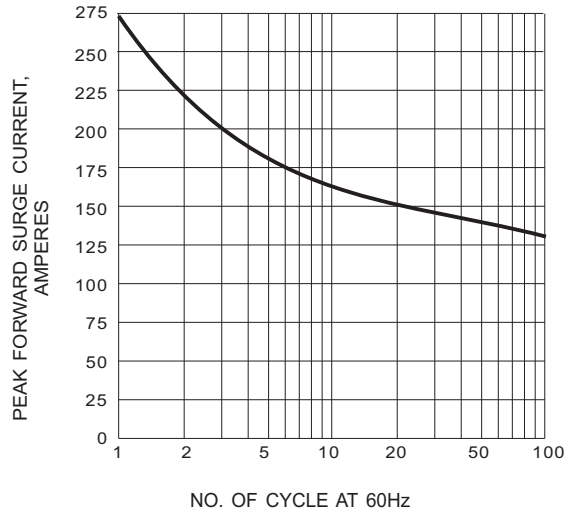

Fig.2- MAXIMUM NON-REPETITIVE SURGE CURRENT

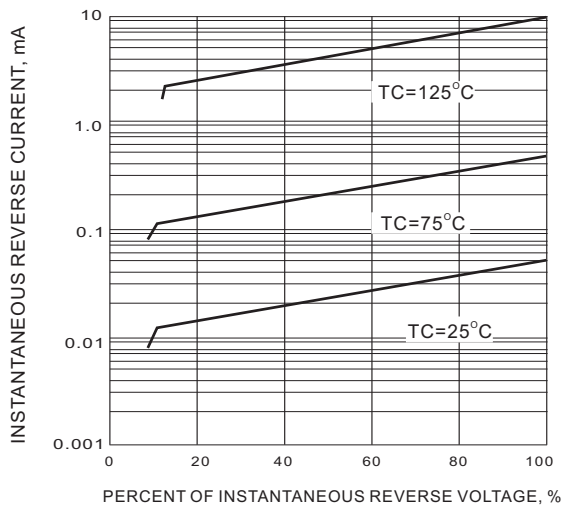

Fig.3- TYPICAL REVERSE CHARACTERISTIC

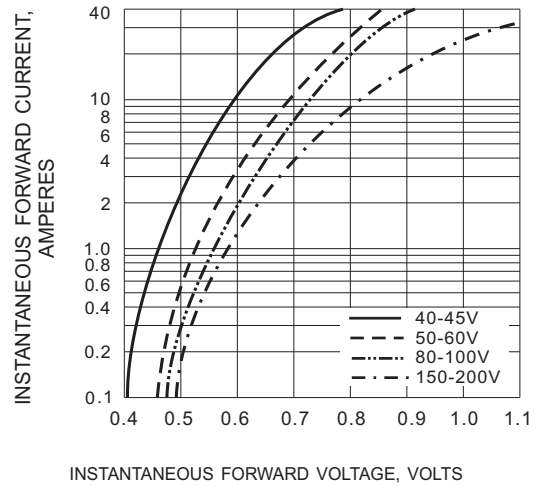
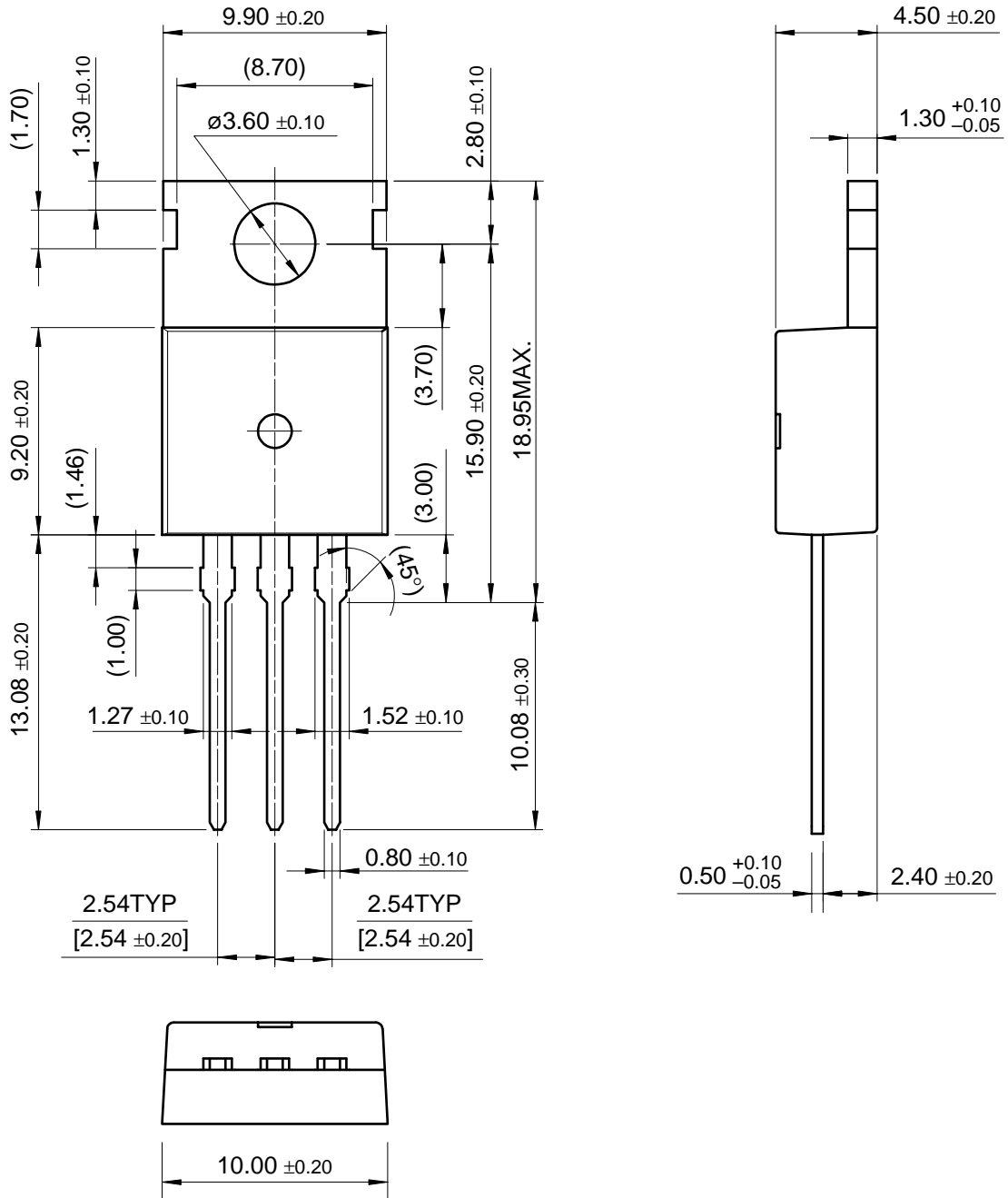

Fig.4- TYPICAL INSTANTANEOUS FORWARD CHARACTERISTIC

Package Dimension

TO-220



Dimensions in Millimeters